



A|Retailer's|Supply|Warehouse,|LLC

GARMENT MERCHANDISING

A RETAILER'S SUPPLY WAREHOUSE, LLC

P.O. Box 2589 - Loveland, CO 80539-2589

Email: kate.mcgee@retailstoredisplays.com

970.613.0061 800.373.2012 Fax 720.269.1112

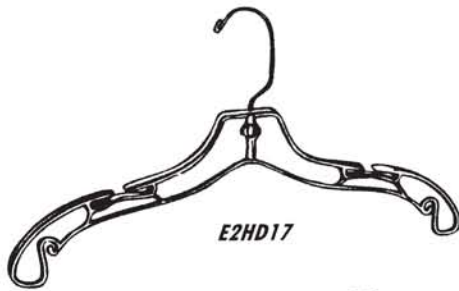

E2HD17

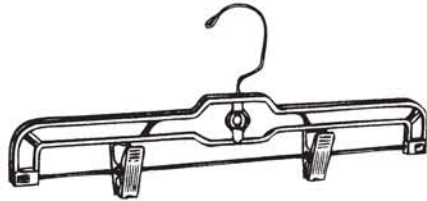

E2HSS14

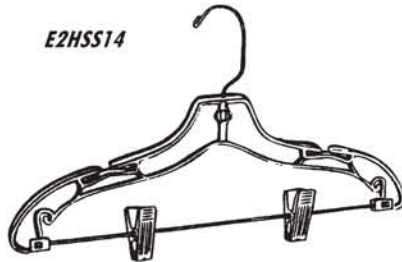

E2HS17

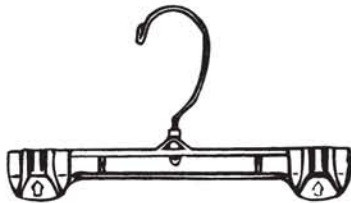

E9HGSS12

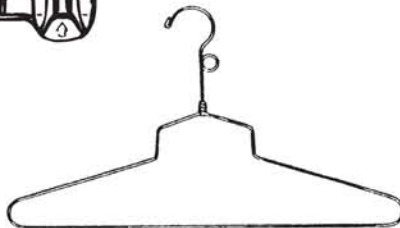

E2HC1723

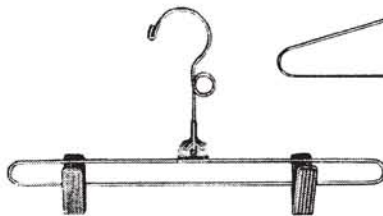

TOP / DRESS HANGERS

Break - resistant plastic with metal swivel hooks. Boxed in quantities of 100.

- E2HD12 12" child size (clear or white)
- E2HD14 14" junior size (clear or white)
- E2HD17 17" adult size (clear, white or black)

PANT / SKIRT HANGERS

Metal clips are adjustable along wire bar. Break - resistant plastic with swivel hooks. Boxed in quantities of 100.

- E2HSS14 14" length (clear, white or black)

"GRIPPER" - STYLE PANT / SKIRT HANGERS

Metal push - up clips allow for easy insertion and removal of garments. Break - resistant plastic with metal swivel hooks. Available in white or black. Boxed in quantities of 200.

- E9HGSS8 8" size BY SPECIAL ORDER
- E9HGSS10 10" size BY SPECIAL ORDER
- E9HGSS12 12" size BY SPECIAL ORDER

SUIT HANGERS

For two - piece outfits. Metal clips are adjustable along wire bar. Break - resistant plastic with swivel hooks. Available in clear or white. Boxed in quantities of 100.

- E9HS12 12" child size BY SPECIAL ORDER
- E9HS14 14" junior size BY SPECIAL ORDER
- E2HS17 17" adult size (clear or white)

CHROME PLATED WIRE HANGERS

Top/dress, pant/skirt and combination suit hangers available in regular style or with neck loops for salesmen's transportation rod. Call for ordering information and pricing.

WOODEN GARMENT HANGERS

These hangers are sure to "class up the joint." Solid hardwood with metal hooks. Boxed in quantities of 100.

- E2HC1723 17" coat hanger
Natural finish & chrome hook
- E9HC1700 17" coat hanger BY SPECIAL ORDER
Walnut finish & brass hook
- E9HSSL3 14" pant hanger BY SPECIAL ORDER
Natural finish & chrome hook
- E9HSS00 14" pant hanger BY SPECIAL ORDER
Walnut finish & brass hook
- E9HS23 17" suit hanger BY SPECIAL ORDER
Natural finish & chrome hook
- E9HS00 17" suit hanger BY SPECIAL ORDER
Walnut finish & brass hook

SOCK HANGERS (black)

- P2SH



P2SH



E2FPS

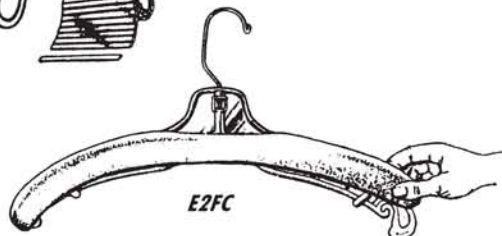

E2FC

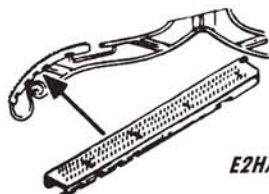

E2HA

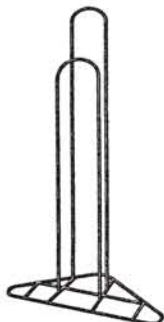

E2HC



E2GP



E2J2



E2SD

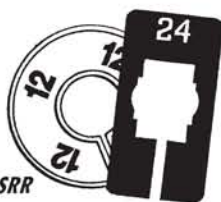

E2SRR

E2SRRE



E2SC

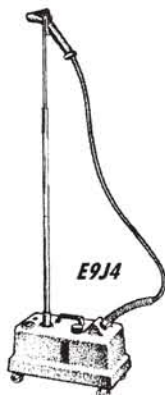

E9J4



E2SM

FOAM PAD HANGER STRIPS

Grey self-adhesive foam strips. Roll of 200 strips.

E2FPS 4" l x 3/8" w

FOAM SLEEVE HANGER COVER

Grey foam stretches over adult size 17" hangers. Bundles of 100.

E2FC

PLASTIC HANGER ATTACHMENTS

Clear vinyl protectors attached to each hanger shoulder. Bags of 200.

E2HA 4" l x 1/2" w

HANGER CADDY

Organizes loose dress, skirt and suit hangers.

E2HC

GARMENT REACH POLE

E2GP

APPAREL SIZE DOTS

3/4" diameter, self-adhesive dots printed in black ink on clear mylar.

Choose from S, M, L, XL, and XXL sizes. Boxed in 500 of each size.

E2SD See size grid in our pricing guide.

ROUND SIZER MARKERS

Fits up to 1 1/2" diameter round tubing. White with black print or black with gold print. Sizes available are: numbers 1 - 54, Petite, Slim - Husky, XS - XXL, 1T - 4T, 3 Month - 36 Month, Infant - Toddler, and Blank.

E2SRR See size grid in our pricing guide.

RECTANGULAR SIZER MARKERS

Fits round, rectangular, and square tubing. White with black print or black with gold print. Sizes available individually are: XS - XXL, Short, Average, Tall and Blank. Additional sizes are available in packages of 100.

BY SPECIAL ORDER

E2SRRE See size grid in our pricing guide.

SNAP - ON HANGER SIZE MARKERS

Fits onto any metal hanger hook. Packed 25 of like size. White with black print. Sizes available are: numbers 3 - 50, Petite, Short, Regular, Tall, Long, S - XXL, 3 Month - 24 Month, 2T, 4T, "Sale," and "One Size."

E2SM See size grid in our pricing guide.

JIFFY - BRAND GARMENT STEAMERS

E2J2 Dependable "J2" unit has a 1-gallon external water tank.

E9J4 "J400" unit has dual-thermostats for quick heating, and an automatic shut-off when the built-in, 1-gallon tank is empty.

BY SPECIAL ORDER

JIFFY STEAMER CLEANER

E2SC

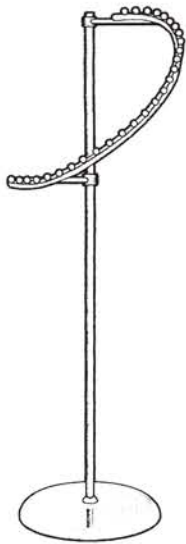

E2SP



E2R36

CHROME SPIRAL RACK

Holds 26 separate garments on cascading spiral loop.

E2SP

CHROME, HEIGHT - ADJUSTABLE ROUND RACKS

With 1 1/4" diameter round tube and folding frame

E2R36 36" dia. hoop

E9R42 42" dia. hoop BY SPECIAL ORDER

CHROME TWO - ARM RACK

With your choice of adjustable straight arms, slant arms, or one of each.

E92 BY SPECIAL ORDER

CHROME FOUR - ARM RACK

With your choice of adjustable arms: all straight arms, all slant arms, or two of each.

E94 BY SPECIAL ORDER

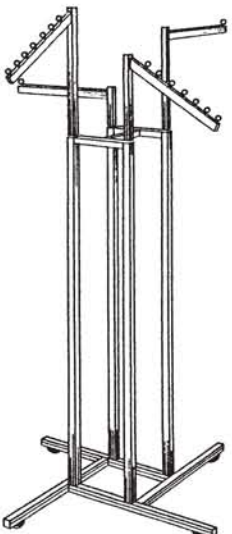

E94



E92

SHELF SUPPORT & ADD - ON BRACKETS

E2TOBS Square Bar

E2TOBR Rectangular Bar

CHROME TRI - LEVEL ROUND RACK

Each 1/3rd section of round rod hangrial is independently height adjustable.

E9TL36 36" diameter BY SPECIAL ORDER

E9TI42 42" diameter BY SPECIAL ORDER

ECONOMICAL SINGLE BAR RACKS

Sturdy black and chrome racks available in two sizes.

E2SB48 48" h x 60" w

E2SB63 63" h x 60" w

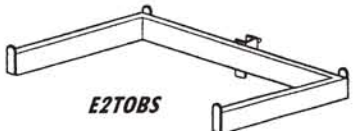

E2TOBS

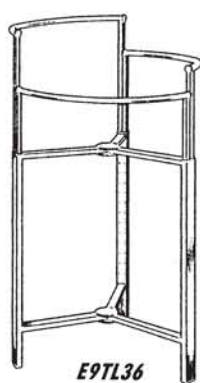

E9TL36



E2SB63

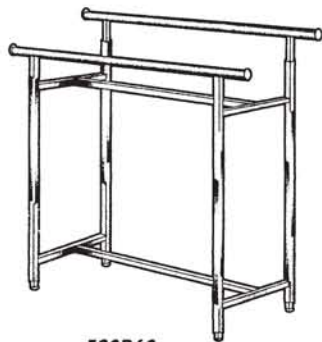

E20B60

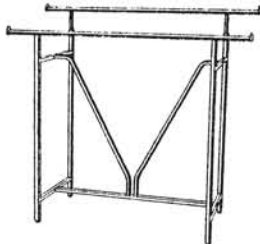

E20BX60

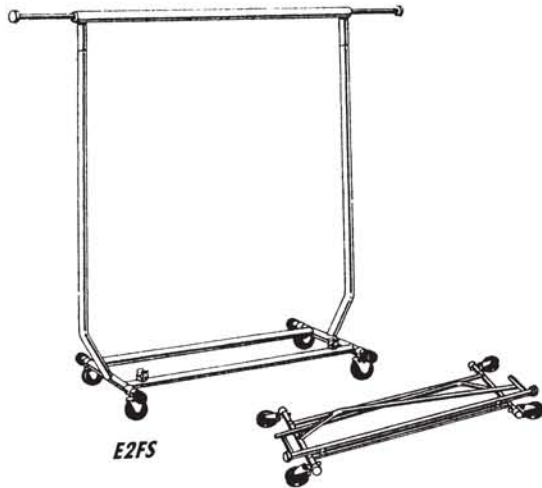

E2FS

CHROME DOUBLE BAR RACKS

60" length racks with adjustable parallel hangrails. Heavy duty unit has diagonal mount bracing for strength.

E20B60

E20BX60 Heavy duty rack

CHROME FOLDING SALESMAN'S RACK

Popular design collapses for storage or transport. 48" hangrail has two 12" extension bars built-in. Height adjustable with heavy duty casters.

E2FS

STOCKROOM "Z" RACK

Rugged 5' rack stands 69" tall and looks good enough for the sales floor.

E2Z

"Z" RACK ADD-ON RAIL

Adjustable rail doubles your rack hanging space.

E2ZR

CASTERS

Casters with plastic wheels available with 5/16", 3/8", and 1/4" threaded posts.

E2B

E2BWB With Brake

WOODEN GARMENT RACKS

OAK PEDESTAL 4 - WAY

Solid 3" square pedestal is available in 59" or 71" heights.

E90459 59" tall - with 16" waterfall arms BY SPECIAL ORDER

E90471 71" tall - with 16" waterfall arms BY SPECIAL ORDER

OAK PEDESTAL ROUNDER

42" diameter chrome ring on 59" tall pedestal.

E90R42 BY SPECIAL ORDER



E2Z



E2B

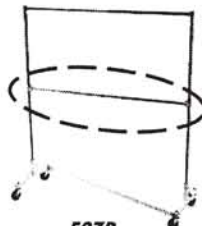

E2ZR

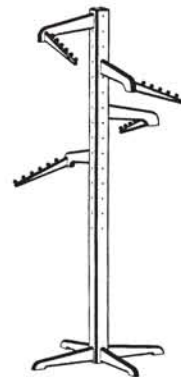

E90459

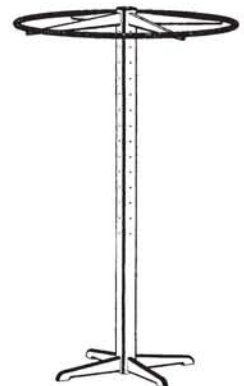

E90R42



E23WM



E90M

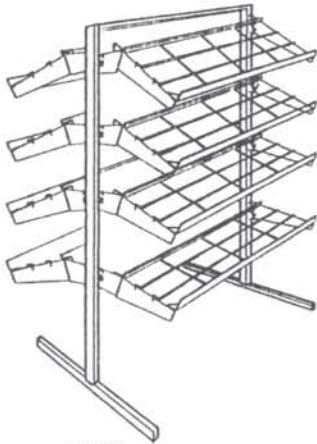

E9SM

E2BSMM

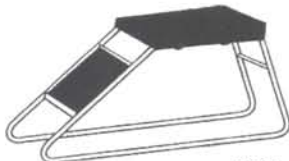
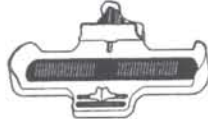

E9SS

THREE - WAY MIRROR

Aluminum framed, free - standing mirror has a 20" w x 60" h center panel with 18" w x 60" h adjustable panels.

E23WM

FREESTANDING MIRROR

Mirror is 20" w x 60" h with your choice of a 24" w x 71" h x 22" d oak or maple frame.

E90M BY SPECIAL ORDER

8 - SHELF SHOE MERCHANDISER

Unit has shelves that tilt from flat to a 45 degree forward tilt.

E9SM 56" h x 48" w BY SPECIAL ORDER

BRANNOCK SHOE MEASURE

Choose from men's, women's, children's and unisex athletic devices.

E2BSMM Men's

E2BSMF Women's

E9BSMC Child's BY SPECIAL ORDER

E9BSMA Unisex athletic BY SPECIAL ORDER

CHROME - FRAMED SHOE STOOL

E9SS 16" h x 16" w x 31" l BY SPECIAL ORDER

COMBINATION MERCHANDISER

2 arms and 4 adjustable shelves provide flexibility in a small space. Your choice of black or chrome frame with black, grey, almond or white shelves.

E9410 BY SPECIAL ORDER

COMBINATION BOX RACK MERCHANDISER

Black or chrome - framed, double hangrail unit with 8 adjustable shelves in black, grey, almond or white.

E9411 BY SPECIAL ORDER



E9410

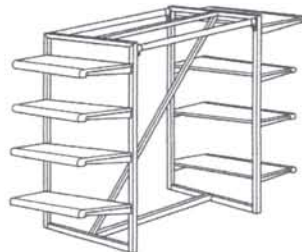

E9411



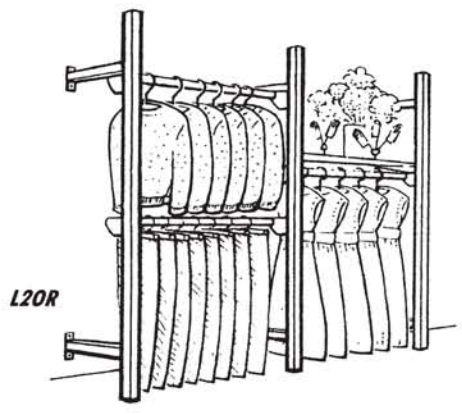

L2OR

OUTRIGGERS

Rear - slotted 1" square uprights are 84" tall and attach to 2 points on wall (or window framing) with included brackets. Accepts your heaviest loads, as majority of weight is transferred to the floor.

L2OR

LADDER SYSTEM

This versatile system provides for wall / perimeter display as well as center / floor racking. Available in black, the system consists of basic units and accessory components that combine to meet your store's specific needs.

- E9301 Center Floor Unit BY SPECIAL ORDER
- E9305 Double Wall Unit BY SPECIAL ORDER

Additional unit configurations are available.

TRAC 2000 WALL SYSTEM

This perimeter display system eliminates the need to fix individual vertical standards to a wall surface. 8' long horizontal track is the only component attached to the wall - vertical standards are then bolted to the track. It's quick and easy to add, remove or relocate standards whenever necessary. Wall tracks are white (paintable). Upright standards available in matte white or matte black.

- E2WAC 96" wall track BY SPECIAL ORDER
- E2MSS94 93" wall standard BY SPECIAL ORDER



E9305

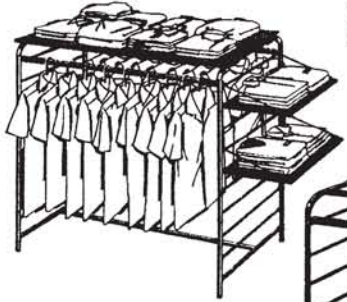

E9301

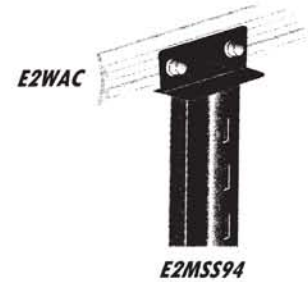

E2WAC

E2MSS94

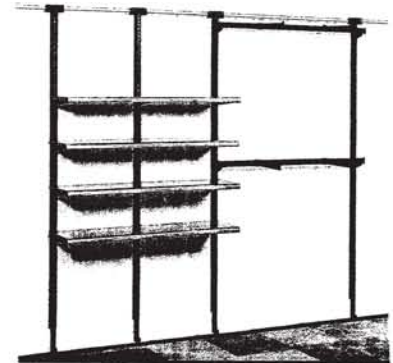

TRAC 2000 INSTALLATION EXAMPLE



E9FC60



E9FC72

CHAINLINK DISPLAY SYSTEM

The urban look of this system makes it the right choice for displaying active wear and sports accessories. Individual panels may be hung on a wall or joined together in self-standing arrangements. Free standing floor units are also available in several configurations. All panel frames are 1 1/4" dia round tubing with universal slotting to accept standard mount hardware. Ask us about this fresh display idea and the various display accessories available for it. Our manufacturer stocks this product in silver, but custom colors are available.

- E9FC60 Hangrail Floor Rack (61 1/2" l x 25" w x 61" h) BY SPECIAL ORDER
- E9FC72 Individual Panel (25" w x 72" h) BY SPECIAL ORDER

PRESTIGE SYSTEMS

An affordable, melamine fixture system that looks custom-made! These beautiful, maple-finished units are simple to assemble and may be ordered in wall-mount or free-standing configurations. Outfit either style with the accessories you need - choose from shelving, hangrods, slatwall sections, or gridwall.

- E9PWU Wall Unit (36" w x 96" h) BY SPECIAL ORDER
- E9PSFU Single Floor Unit 36" l x 54" h) BY SPECIAL ORDER
- E9PDFU Double Floor Unit (36" l x 30" w x 54" h) BY SPECIAL ORDER

The PRESTIGE line also includes a trio of beautifully-finished display tables, each available in a matching maple or rich cherry finish. Choose from square or rectangular-tiered tables, or a set of three nesting tables.

- E9PRTT 3-Tier Rectangular (66" l x 42" w x 39" h) BY SPECIAL ORDER
- E9PSTT 3-Tier Square (48" l x 48" w x 39" h) BY SPECIAL ORDER
- E9PNT 3-pc. Nesting (1- 46" x 16" w x 16" h) BY SPECIAL ORDER
 (2- 56" x 20" w x 20" h)
 (3- 66" x 36" w x 32" h)



E9PWU



E9PSFU

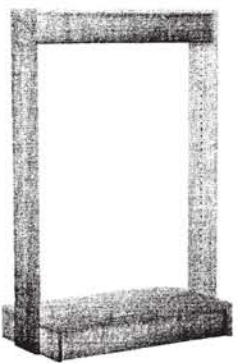

E9PDFU

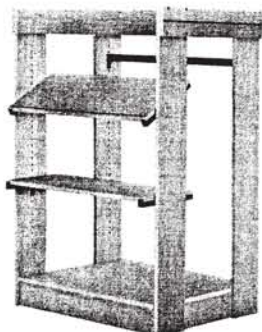

E9PSTT



E9PNT



Also available in the PRESTIGE LINE are matching maple Showcases, Counters, and free-standing Slatwall units!

FASHION FORMS
 These molded plastic forms are the economical choice!

E22
 Junior w/ neck
 Sizes 5 - 10
 31" x 15" x 3"
 clr / wht



E213
 Misses
 Sizes 12 - 16
 30" x 16" x 4"
 clr / wht / blk

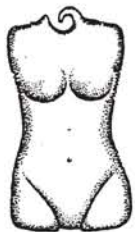

E24
 Junior Sexy
 Sizes 5 - 10
 29" x 18" x 5"
 clr / wht / blk



E214
 Misses
 Sizes 12 - 16
 30" x 16" x 4"
 clr / wht / blk



E25
 Junior Bra
 Sizes 32B - 36C
 18" x 15" x 3"
 clr / wht



E215
 Girls
 Sizes 7 - 14
 23" x 13" x 1"
 clr / wht / blk



E28
 Men's Shirt
 Sizes Med & Up
 28" x 23" x 5"
 clr / wht / blk



E217
 Little Girls
 Sizes 4 - 6x
 19" x 11" x 1"
 clr / wht / blk



E211
 Junior
 Sizes 5 - 10
 27" x 15" x 3"
 clr / wht / blk



E219
 Misses Sexy
 Sizes 10 - 14
 28" x 21" x 5"
 clr / wht / blk

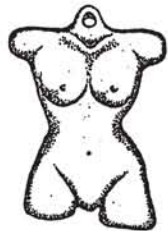

E225
 Misses Bra Form
 Sizes 34D - 36C
 15" x 15 1/2" x 4"
 clr / wht / blk



E227
 Female Chest
 Sizes Med. & Up
 21" x 19 1/2" x 4 3/4"
 clr / wht / blk

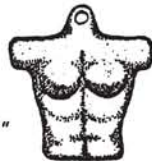

E229
 Infant Torso
 Sizes 1M - 24M
 15 1/2" x 9" x 1 1/2"
 clr / wht / blk



E233
 Male Torso
 Sizes Small & Med.
 30 1/2" x 20 1/2" x 3"
 clr / wht / blk

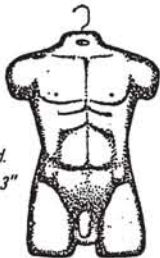

E934
 Heavy Gauge Female Torso
 Sizes Junior 5 - 10
 29 1/2" x 17" x 6 1/2"
 wht / blk
 BY SPECIAL ORDER



E936
 Heavy Gauge Child's Torso
 Sizes 2T - 4T
 22 1/2" x 12 1/2" x 4"
 wht / blk
 BY SPECIAL ORDER



E937
 Heavy Gauge Maternity form
 Sizes Med, 6M - 9M
 30 1/2" x 17 1/2" x 8 1/2"
 wht / blk
 BY SPECIAL ORDER

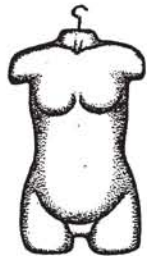

E241
 Children's Chest Form
 Sizes 2T - 4T
 18 1/2" x 15 1/2" x 3 1/2"
 clr / wht / blk



E242
 Men's Chest Form
 Self - Standing
 Sizes Med. & Up
 25" x 20 1/2" x 3 1/2"
 wht / blk

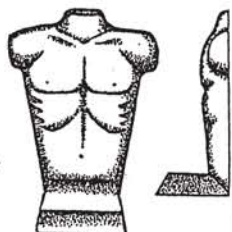

E243
 Women's Chest Form
 Self - Standing
 Sizes Med. & Up
 24" x 19 1/2" x 4 1/2"
 wht / blk

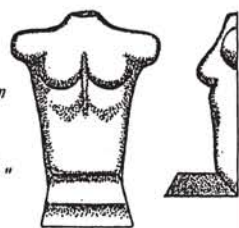

E245
 Shoulder form w/ Drop
 17" x 5" x 4 1/2"
 wht / blk



E246
 Children's Chest Form
 Self - Standing
 Sizes 2T - 6T
 21" x 15 1/2" x 3 1/2"
 wht / blk

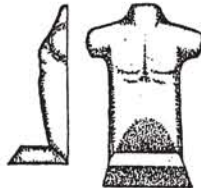

E912
 Heavy Gauge Men's Torso
 Size Large
 38" x 24" x 5"
 wht / blk
 BY SPECIAL ORDER

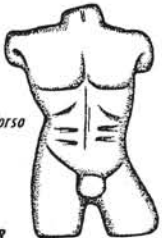

E221
 Men's Shirt - Small
 Sizes Small & Up
 22" x 20" x 3"
 clr / wht / blk



E947
 Men's Head Form
 Self - Standing
 Sizes - All
 15 1/2" x 7" x 4 1/2"
 wht / blk

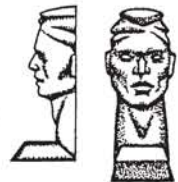

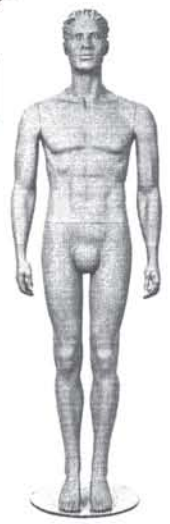

E2MM



E280S/B



E2FM



E215F

FULL-BODIED MANNEQUINS

Male and Female with molded hair are of top quality and priced right!

- E2MM** MALE
- E2FM** FEMALE

TORSO FORMS

- E280S/B** Men's torso form in "Suntan" brown finish w/wooden base.
- E215F** Women's torso form in "Fleshtone" finish w/wooden base.

SHIRT / BLOUSE FORMS

These forms will stand alone, or may be mounted to a post and base (below).

- E281S** Men's shirt form in "Suntan" brown finish.
- E230F** Women's blouse form in "Fleshtone" finish.

FRENCH FORMS

Stylish upper torso forms made from easily pinnable, molded polyurethane with an off-white jersey fabric cover.

- E2MCFX** Men's shirt form with neck block and base.
- E2FCHX** Women's blouse form with neck block and base.
(these forms also available without neck block or base)

If you need a specific MANNEQUIN or FORM not shown here, please let us know. We'll order what you need!



E2MCFX



E2FCHX



E281S



E285S

TRUNK FORM

- E285S** "Suntan" finish

FLEXIBLE FORMS

Black velvet-like finish over flexible rod allows for unlimited positioning. Hang them on the wall or other fixture, or mount to a post and base (below).

- E2FF80** Adult-size form
- E2FF81** Child-size form

POSTS & BASES

For use with display forms or sign frames, simply combine one of our post lengths with the base of your choice.

- E2B6** 6" dia. base x 5/8" fitting
- E2B8** 8" dia. base x 5/8" fitting
- E2U8** 24" long post x 5/8" thread
- E2U9** 30" long post x 5/8" thread
- E2U10** 36" long post x 7/8" thread
- E2U5A** 18" - 36" adjustable length post x 5/8" fitting
- E2U6A** 24" - 48" adjustable length post x 5/8" fitting
- E2U7A** 36" - 72" adjustable length post x 5/8" fitting

STYROFOAM HEAD FORMS

Economical and 100% recyclable display forms available in several styles.

- E2F800WH** Female head
- E2U695WH** Unisex head
- E2M627H** Male head



E2F800WH



E2U695WH



E2M627H

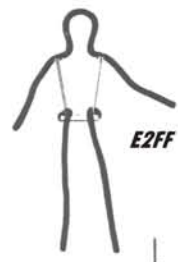

E2FF



E2U

E2B

WE ALSO STOCK
SLATWALL AND GRIDWALL
MOUNTING BRACKETS
FOR THESE FORMS!
B2SHB1 Slatwall
C2SHB1 Gridwall