



A|Retailer's|Supply|Warehouse,|LLC

GRID WALL

A RETAILER'S SUPPLY WAREHOUSE, LLC

P.O. Box 2589 - Loveland, CO 80539-2589

Email: kate.mcgee@retailstoredisplays.com

970.613.0061 800.373.2012 Fax 720.269.1112

A longtime favorite for the portable display, GRIDWALL's flexibility and strength make it a great choice in the showroom as well. Mount it on the wall, construct free-standing displays, or hang it from the ceiling.

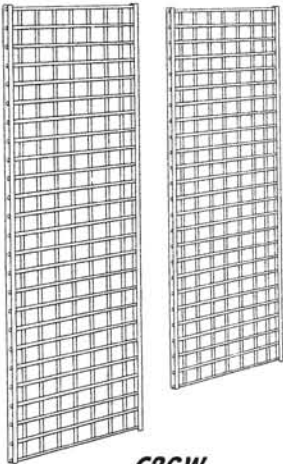

C2GW



C9SG

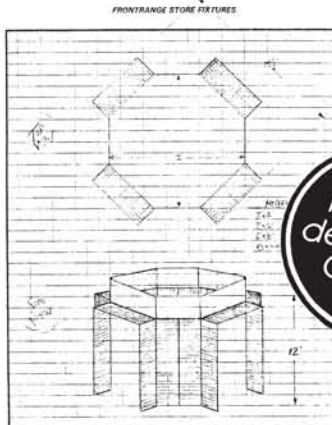
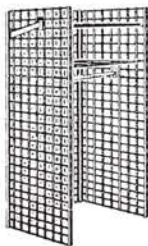
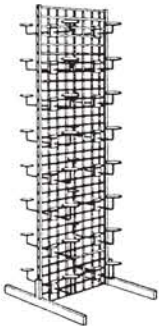
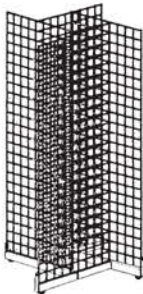
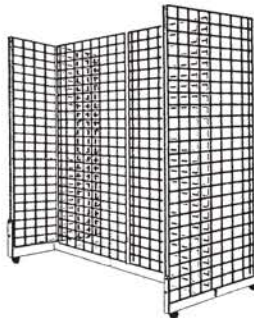
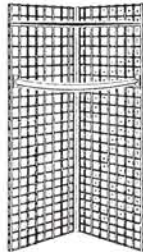
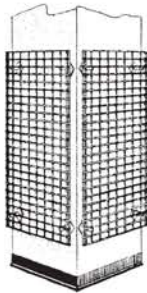
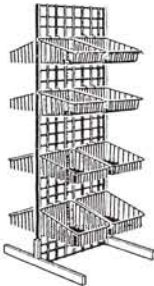

GRIDWALL

Available in chrome, white and black finishes

C2GW15	1' x 5'
C2GW16	1' x 6'
C2GW24	2' x 4'
C2GW25	2' x 5'
C2GW26	2' x 6'
C2GW27	2' x 7'
C2GW21	2' x 8'
C2GW44	4' x 4'

SLATGRID

The convenient, money-saving design of SLATGRID allows you to utilize either Gridwall or Slatwall hardware. Available in chrome, white, and black finishes.

C9SG24	2' x 4'	BY SPECIAL ORDER
C9SG25	2' x 5'	BY SPECIAL ORDER
C9SG26	2' x 6'	BY SPECIAL ORDER
C2SG27	2' x 7'	
C9SG28	2' x 8'	BY SPECIAL ORDER
C9SG44	4' x 4'	BY SPECIAL ORDER

Let us help you design your Gridwall kiosk!

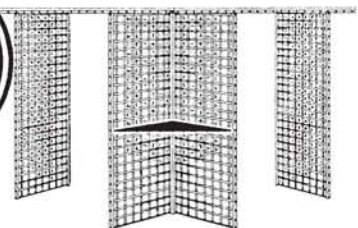

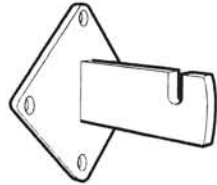
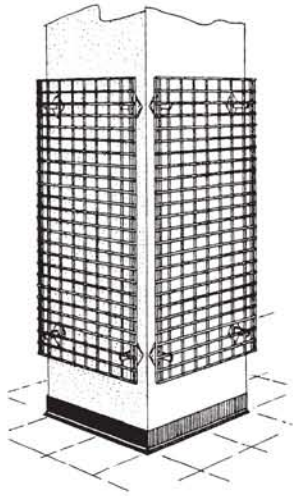

C2WMB

WALL MOUNTING BRACKET (chrome, white, or black)

C2WMB

"BUTTERFLY" STYLE JOINING CLIP (chrome, white, or black)

C2J

HEAVY DUTY JOINING CLIP (chrome, white, or black)

C2HDJ

HEAVY DUTY CORNER JOINING CLIP (chrome, white, or black)

C2HDCJ

SUPPORT LEGS (chrome, white, or black)

C2L

GONDOLA BASE (chrome, white, or black)

C2GB 24" w x 48" l

4 - PANEL BASE WITH CASTERS (chrome, white, or black)

C2FPB 36" w x 36" l

TRIANGLE BASE WITH CASTERS (chrome, white, or black)

C2TB 24" x 24" x 24"

GRIDWALL CASTER ASSEMBLY

For use on corners of triangular Gridwall formations.

C2CA



C2J

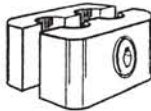

C2HDJ

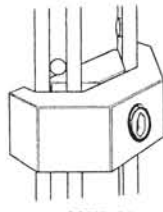

C2HDCJ

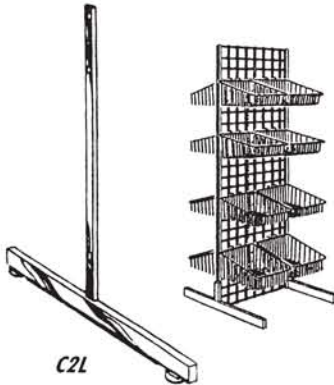

C2L

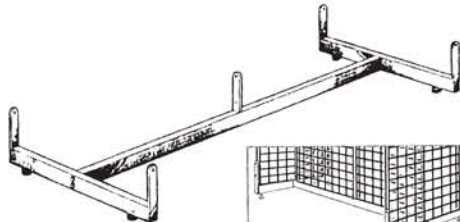

C2GB

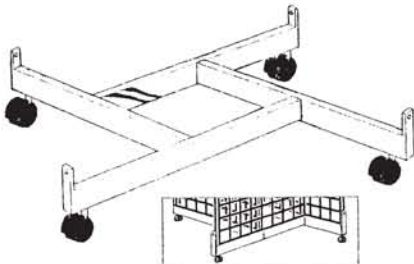

C2FPB

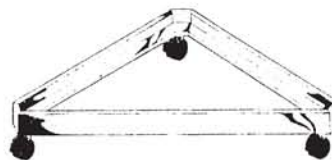

C2TB

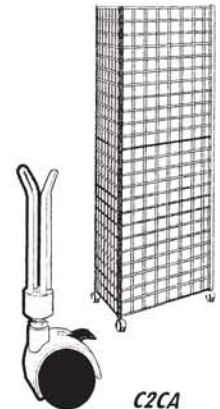

C2CA

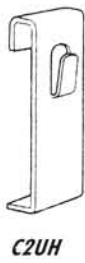

C2UH

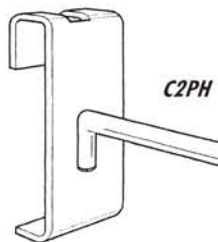

C2PH



C2SB



P2SR

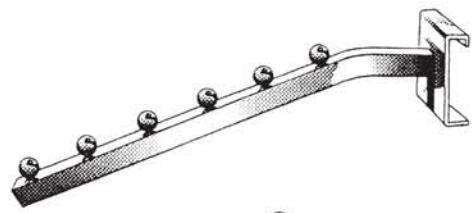

C2WF



C2FO

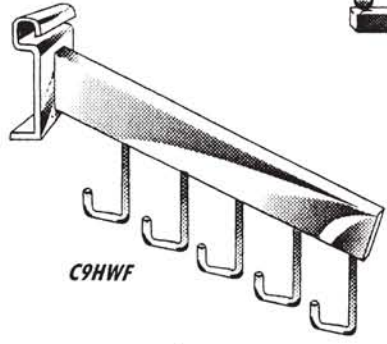

C9HWF



P2SH

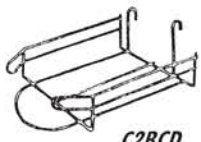

C2BCD



C2HCS



P2SWC

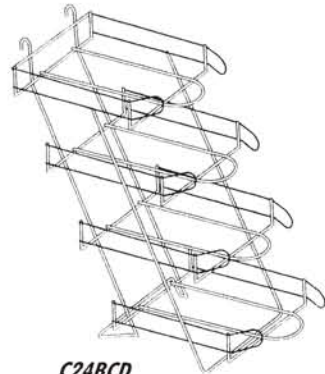

C24BCD



C2HP



P2HPF

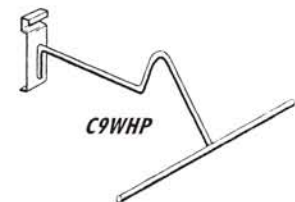

C9WHP

UTILITY HOOK (chrome, white, or black)

C2UH

DISPLAY HOOKS (chrome, white, or black)

- C2PH2 2"
- C2PH4 4"
- C2PH6 6"
- C2PH8 8"
- C2PH10 10"

SHELF BRACKETS (chrome, white, or black)

- C2SB8 8"
- C2SB10 10"
- C2SB12 12"
- C2SB14 14"

SHELF REST (zinc finish)

P2SR

WATERFALL - BALL STYLE (chrome, white, or black)

C2WF

FACEOUT (chrome, white, or black)

C2FO

WATERFALL - HOOK STYLE (chrome)

C9HWF

S - HOOK

- P2SH 7/8" long
- P2SH2 2" long

SWIVEL CLIP (white or black)

- P2SWC 1 7/8" long
- P2SWCX 4 1/8" long

HERCULES CLIP (white or black)

C2HCS

WIRE BALL CAP DISPLAYER (chrome, white, or black)

C2BCD

4 - STYLE WIRE BALL CAP DISPLAYER

- C24BCD (chrome)
- C94BCD (white or black) **BY SPECIAL ORDER**

HAT PEG (chrome, white, or black)

C2HP

GREY HAT PEG FOAM

P2HPF

WESTERN HAT PEG (chrome)

C9WHP **BY SPECIAL ORDER**

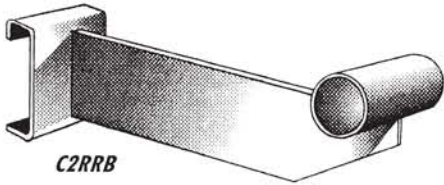

C2RRB

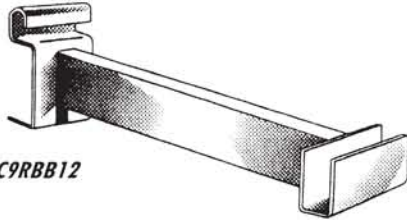

C9RBB12

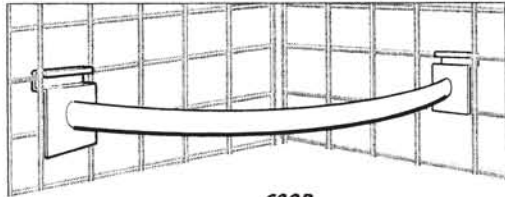

C2QB

Our
ACRYLIC
GRIDWALL
ACCESSORIES
begin on
page
A10

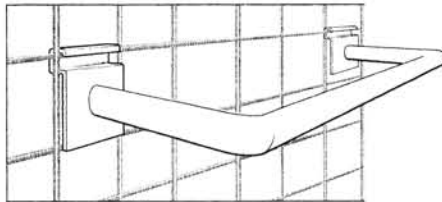

C2UB

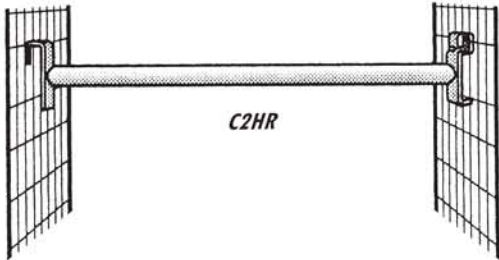

C2HR

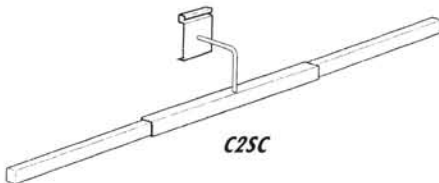

C2SC

12" ROUND ROD BRACKETS (chrome)

C2RRB For 1" diameter rod

C2RRBX For 1 1/4" diameter rod

12" RECTANGULAR BAR BRACKET (chrome)

C9RBB12 BY SPECIAL ORDER

QUARTER CIRCLE BAR (chrome, white, or black)

C2QB

"U" BAR (chrome, white, or black)

C2UB

48" HANGRAIL BAR (chrome, white, or black)

C2HR

"SCARECROW" SHIRT DISPLAYER (chrome, white, or black)

C2SC

ADJUSTABLE WIRE LITERATURE HOLDER (white)

C2ALH

WIRE EASEL (white only)

C2GE (not pictured)

WIRE - BOOK / SOFTWARE DISPLAYER (white, black, or silver)

C9BSD BY SPECIAL ORDER

WIRE COMPACT DISC DISPLAYER (chrome)

C9CDD BY SPECIAL ORDER

BALL DISPLAYER (chrome, white, or black)

C9BD BY SPECIAL ORDER

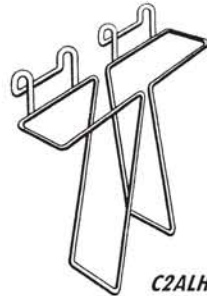

C2ALH

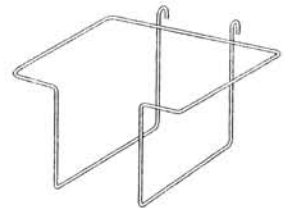

C9CDD



C9BSD

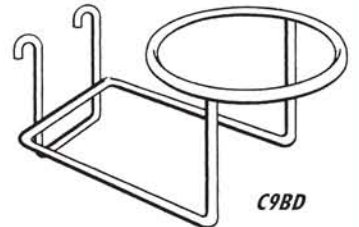

C9BD



C22424

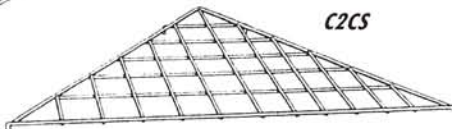

C2CS

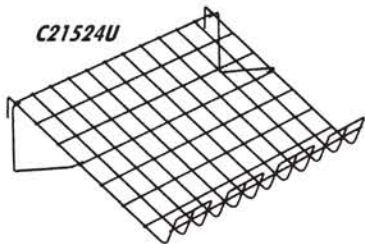

C21524U

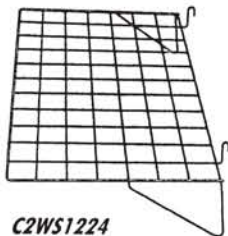

C2WS1224

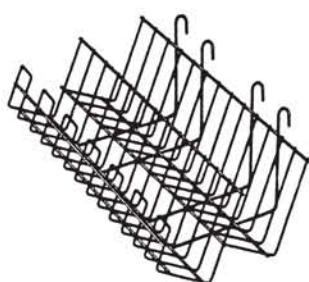

C22T

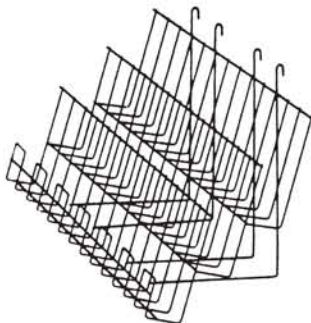

C23T

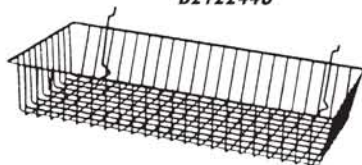

B212244U



B21266U

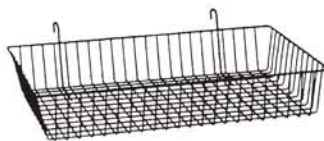

C212244



C212128SL



B2DSL U



C212124



C212128

DROP - IN SHELF (chrome, white, or black)

C22424 24" w x 24" l

CORNER DROP - IN SHELF (chrome, white, or black)

C2CS

FLAT SHELF (silver, white, or black)

C2WS1224 12" w x 24" l

" UNIVERSAL " SLANTED SHELF (chrome, white, or black)

C21524U 15" w x 24" l

TWO - TIERED VIDEO / CD / BOOKSHELF (white or black)

C22T

THREE - TIERED VIDEO / CD / BOOKSHELF (white or black)

C23T

WIRE BASKETS (chrome, white, or black)

C212124 12" d x 12" w x 4" h

C212128 12" d x 12" w x 8" h

C212244 12" d x 24" w x 4" h

C212128SL 12" d x 12" w x 8" h w/ SLOPED SIDES (white only)

" UNIVERSAL " WIRE BASKETS (white, black, or silver)

B21266U 12" d x 6" w x 6" h

B212244U 12" d x 24" w x 4" h

B2DSL U 10" d x 24" w x 5" h w/ SLOPED FRONT & BACK

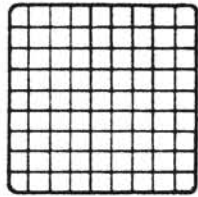

C2MG

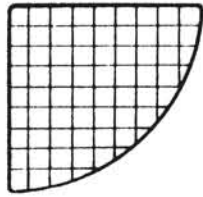

C2MGQ

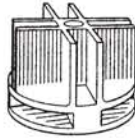

C2MGC



A21351

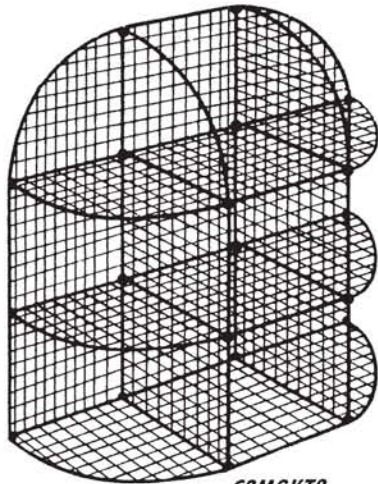

C2MGKT2

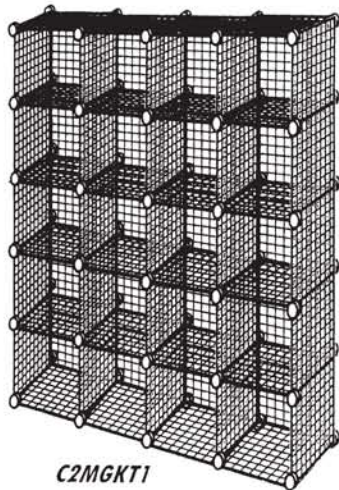

C2MGKT1

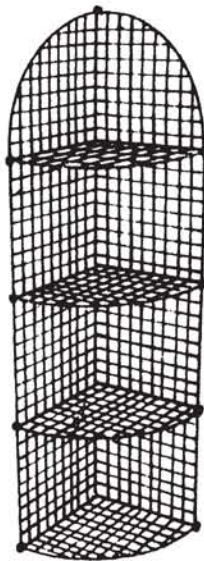

C2MGKT3

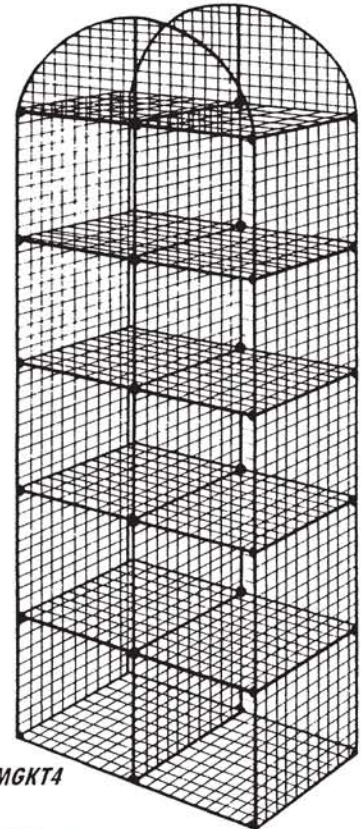

C2MGKT4

MINI - GRID DISPLAY SYSTEM

White or black plastic - coated wire panels fasten together quickly. Choose one of our kits or create your own design.

14" X 14" SQUARE PANEL (white or black)

C2MG

14" QUARTER ROUND PANEL (white or black)

C2MGQ

GRID CONNECTOR (white or black)

C2MGC

CLEAR ACRYLIC DROP - IN SHELF LINER

A21351

Save time by ordering one of our *Mini - Grid Kits*. Each comes with required panels and connectors to build units exactly as illustrated. Choose kit number and either white or black finish.

C2MGKT1 61" w x 76^{1/4}" h x 15^{1/4}" d

C2MGKT2 45^{3/4}" w x 45^{3/4}" h x 15^{1/4}" d

C2MGKT3 21^{1/4}" w x 61" h x 15^{1/4}" d

C2MGKT4 30^{1/2}" w x 91^{1/2}" h x 15^{1/4}" d