



A|Retailer's|Supply|Warehouse,|LLC

## MERCHANDISING & PROMOTIONAL AIDES

**A RETAILER'S SUPPLY WAREHOUSE, LLC**

P.O. Box 2589 - Loveland, CO 80539-2589

Email: [kate.mcgee@retailstoredisplays.com](mailto:kate.mcgee@retailstoredisplays.com)

970.613.0061    800.373.2012    Fax 720.269.1112

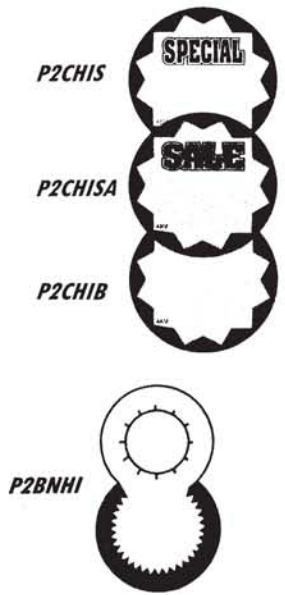
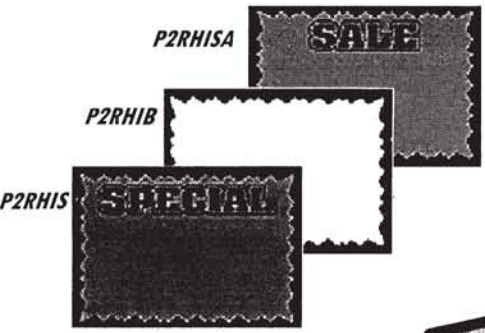
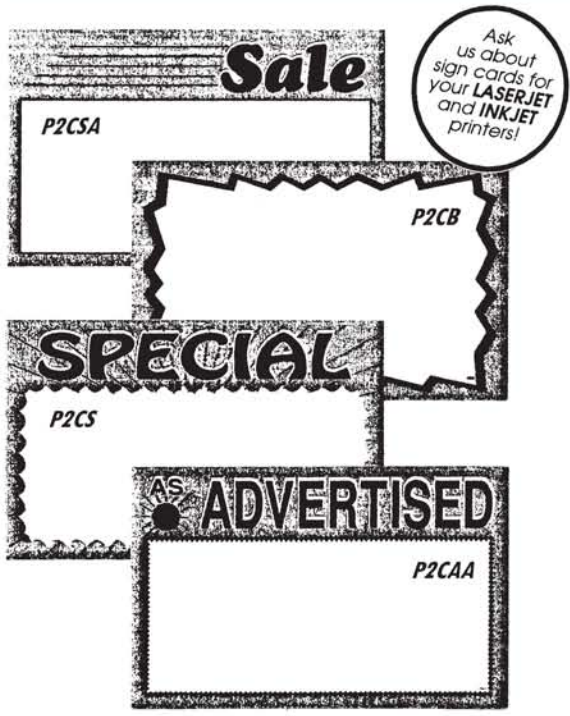

**POINT - OF - SALE SIGN CARDS**

Sold individually or in packages of 100.

	Card Size	Style	Colors
P2CSA35	3 1/2 " h x 5 1/2 " w	"Sale"	Red / Orange
P2CB35		(Blank)	Red / Orange Light Green
P2CS35		"Special"	Red / Orange Light Green
P2CAA35		"As Advertised"	Red / Orange
P2CSA57	5 1/2 " h x 7 " w	"Sale"	Red / Orange
P2CB57		(Blank)	Red / Orange Light Green
P2CS57		"Special"	Red / Orange Light Green
P2CAA57		"As Advertised"	Red / Orange Light Green
P2CSA711	7 " h x 11 " w	"Sale"	Red / Orange
P2CB711		(Blank)	Red / Orange Light Green
P2CS711		"Special"	Red / Orange
P2CAA711		"As Advertised"	Red / Orange
P2CB1114	11 " h x 14 " w	(Blank)	Red / Orange Light Green
P2CAA1114		"As Advertised"	Red / Orange
P2CCMP1114		"Compare & Save"	Red / Orange

**HI - IMPACT PRICE CARDS**

Extremely bold colors will get the attention of your customers! Packages of 100 (25 each of red, yellow, magenta and green).

	Card Size	Style
P2RHISA	2 1/2 " h x 3 1/2 " w	"Sale"
P2RHIB		(Blank)
P2RHIS		"Special"
P2CHISA	3 1/4 " dia. circular	"Sale"
P2CHIB		(Blank)
P2CHIS		"Special"
P2BNHI	3 1/4 " dia. Bottle Neck	(Blank)

**HI - IMPACT SHELF ARROWS**

2 1/2 " h x 5 1/2 " w heavy card stock is printed on both sides using bold red and black inks.

P2AHIS	"Special"
P2AHIN	"New Item"
P2AHIR	"Reduced Price"
P2AHIB	(Blank)
P2AHIE	"Espcial"



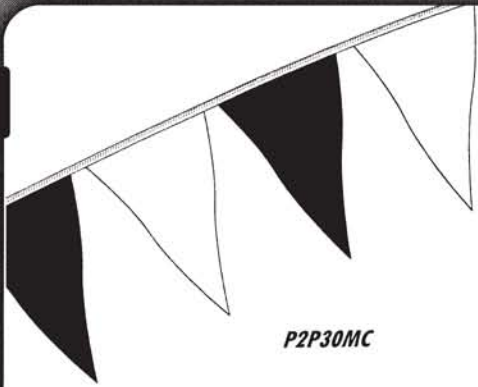

P2P30MC



P2P60SS

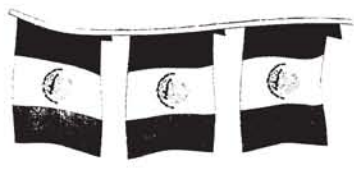

P2P30MEX

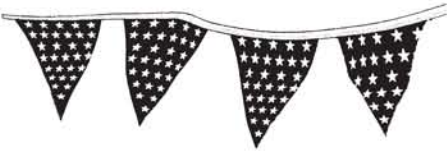

P2P60AM

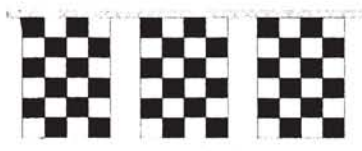

P2P60CHF



P2P60CHP

**PENNANT AND FLAG STRINGS**

All feature polyethylene material sewn onto sag - resistant, hi - strength nylon rope ties.

	<u>Length</u>	<u># of Pennants / Size / Style</u>
P2P30RWB	30 feet	Twelve, 12" x 18" Red / White / Blue Pennants
P2P30MC	30 feet	Twelve, 12" x 18" Multi - Colored Pennants
P2P30MEX	30 feet	Fifteen, 9" x 12" Mexican National Flags
P2P30AP	30 feet	3/4" x 18" Red / Blue / White Alternating panels
P2P60AP	60 feet	3/4" x 18" Red / Blue / White Alternating panels
P2P60MC	60 feet	Thirty-six, 9" x 12" Multi - Colored Pennants
P2P60AM	60 feet	Twenty-four, 12" x 18" Red / Blue / White Pennants
P2P30CHP	30 feet	Twelve, 12" x 18" Black / White Checkered Pennants
P2P60CHF	60 feet	Thirty, 9" x 12" Black / White Checkered Flags
P2P60SS	60 feet	Twenty-four, 12" x 18" American National Flags
P2P105MC	105 feet	Forty-eight, 12" x 18" Multi - Colored Pennants
P2P110MC	110 feet	Eighty, 6" x 18" Multi - Colored Pennants

Additional pennant styles are available! Choose from holiday themes to international flag combinations.

**CLOTH BANNER**

Heavy duty, "weatherized" cloth signs with fluorescent red, blue, white and yellow coloring are available in two sizes. Nylon rope ties are sewn into top and bottom of banners for superior strength.

<u>3' h x 5' w</u>		<u>3' h x 10' w</u>
P2BOS60	"Opening Soon"	P2BOS120
P2BGO60	"Grand Opening"	P2BGO120
P2BNO60	"Now Open"	P2BNO120
P2BO60	"Open"	P2BO120
P2BCS60	"Clearance Sale"	P2BCS120
P2BGS60	"Gigantic Sale"	P2BGS120
P2BS60	"Sale"	n/a
P9HW60	"Help Wanted"	P9BHW120
P2BOH60	"Open House"	P2BOH120



P2S0C



P2S0CM

BUSINESS HOURS:	
Mon.	to
Tue.	to
Wed.	to
Thu.	to
Fri.	to
Sat.	to
Sun.	to

P2SBH

OPEN / CLOSED SIGN

Heavy gauge plastic sign with one side "OPEN" (in red) and the other CLOSED (in black).

P2S0C 20" w x 13" h

BUSINESS HOURS SIGN

Heavy plastic placard (red)

P2SBH 8 1/2" w x 11" h

OPEN / CLOSED MESSAGE BOARD

Message board slides up and down to reveal "Open" or "Closed" sign. Unit includes 300 red and black 1/2" letters and four glass-mounting suction cups.

P2S0CM 14" w x 20" h

CLIP - ON SIGNS

3 1/2" w x 2" h placards mounted to both sides of a universal clamp. Red print on white plastic.

P2CLSA "Sale"

P2CLSP "Special"

SALE POSTER

Heavy coated white paper sign with blue grid and magenta text.

P2P104 22" w x 29" h

CUTOUT SALE SIGN

Foam core cutout sign with red letters.

P2S190 44" w x 16" h

SALE SIGN

White foam core sign with red text.

P2S161 32" w x 16" h

TRI-FOLD SALE SIGN

3-sided, white foam core sign with red text will free-stand or hang from the ceiling.

P2S169 32" w x 16" h

OVAL SALE SIGN

White foam core sign with vertical red text hangs vertically for maximum exposure.

P2S164 12" w x 36" h

INFORMATION SIGNS

Black plastic signs measure 9" w x 5 1/2" h.

P9S001 "NO REFUND ON SALE MERCHANDISE"

P9S002 "ALL SHOPLIFTERS WILL BE PROSECUTED"

P9S009 "NO FOOD OR DRINKS"

STATIC CLING WINDOW "SALE" SIGN

36" w x 24" h sign with orange text.

P2S104

STATIC CLING WINDOW SIGN KIT

Simply press reusable lettering onto any clean glass surface to create professional-looking signs. 5" high, "Day-Glow" red letters.

P2SSC



P2P104



P2CLSA



P2CLSP



P2S190



P2S161



P2S104



P2SSC



P2S164



P2S169



P9S001



P9S002

Ask us about our new  
**ELECTRIC  
BLACKBOARD.**  
With it's bright neon markers  
and brilliant illumination,  
this one's perfect for your  
specials and promotions!



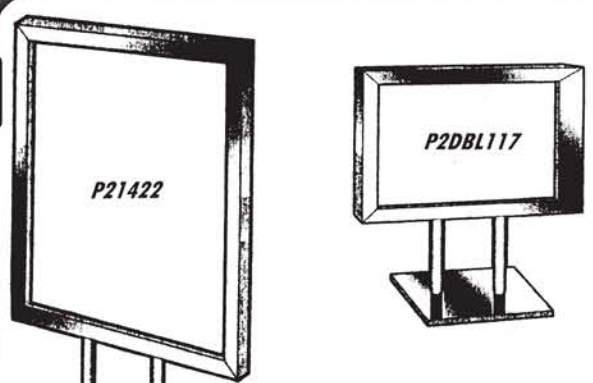

**SIGN HOLDERS**  
 Floorstanding units available in two sizes:  
**P21422** 53" tall for 14" w x 22" h signs (Chrome)  
**P22228** 59" tall for 22" w x 28" h signs (Chrome)  
**P22228X** 59" tall for 22" w x 28" h signs (Black)

**SIGN FRAME**  
**P2DBL117** 11" w x 7" h chrome, counter-top unit with double post base.

**RACK SIGNAGE COMPONENTS**  
 Choose a sign frame, stem and mounting clamp, or magnet. All parts have 3/8" fittings and are available in chrome finish.

<u>Sign Frames:</u>	<u>Size (w x h)</u>	<u>Frame Style</u>
<b>P2MC75</b>	7" x 5 1/2"	Mitered Corners
<b>P2RC75</b>	7" x 5 1/2"	Rounded Corners
<b>P2MC117</b>	11" x 7"	Mitered Corners
<b>P2RC117</b>	11" x 7"	Rounded Corners

**Stems:**

<b>P2ST3</b>	3" length
<b>P2ST6</b>	6" length
<b>P2ST9</b>	9" length
<b>P2ST12</b>	12" length

**Clamps / Magnets:**

<b>P2CRB</b>	Rectangular Bar Clamp Mount
<b>P2CSB</b>	Square Bar Clamp Mount
<b>P2MAGF</b>	Flat Magnet Mount
<b>P2MAGS</b>	Square Magnet Mount

**UNIVERSAL SIGN CLIP**  
 Clamps to virtually any fixture. Clear plastic construction with swivel-mounted clip for sign card. 1" wide mounting clamp is attached to 3" wide sign card clip.  
**P2UC**

**HANGING LABEL HOLDER**  
 Flexible plastic sleeve attaches to fixturing with two plastic split rings.  
**P2FPLH** 4 3/4" w x 1 3/4" h

**SHELVING TICKET HOLDERS**  
 Clear plastic pieces made to fit specified types of shelving.

	<u>Shelving Type</u>	<u>Ticket Holder Size (w x h)</u>
<b>P2STHG3</b>	1/4" thick glass	3" x 3/8"
<b>P2STHG2</b>	1/4" thick glass	2 7/8" x 7/8"
<b>P2STHW2</b>	3/4" thick wood	2 7/8" x 7/8"
<b>P2STHW48</b>	3/4" thick wood	48" x 7/8"
<b>P2STHL</b>	"Lozier S - Style"	2 7/8" x 1 1/4"

**TICKET HOLDERS FOR ROUND WIRE STOCK**

	<u>Mounting</u>	<u>To Fit</u>
<b>P2SHW</b>	Clamp - on	1/4" dia - stock only
<b>P2SHWH</b>	Hang - on	Up to 3/8" dia stock

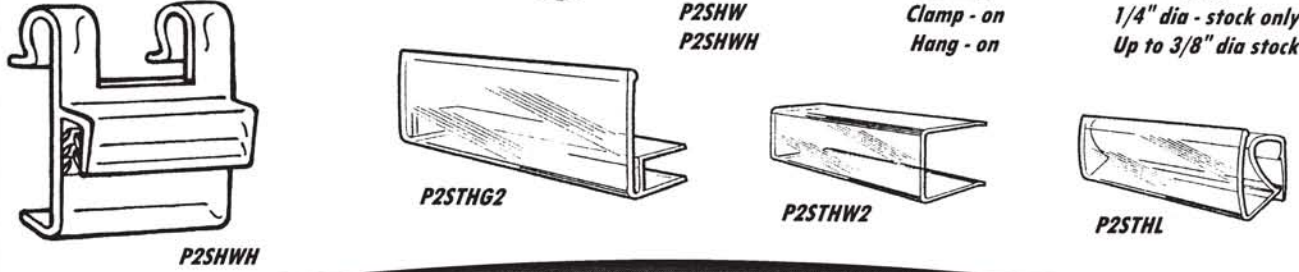
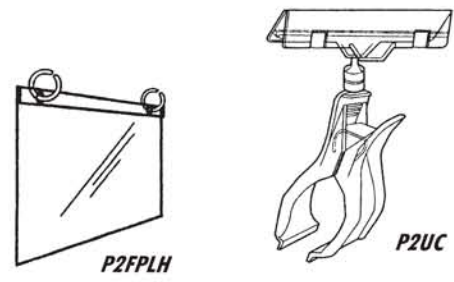
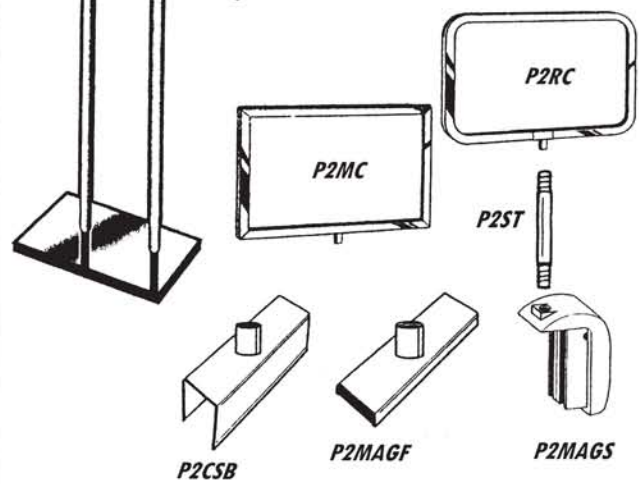

P22A



P23A

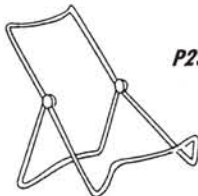

P24PL



P2MI



**DISPLAY EASELS**

All are sold individually or by the dozen

	<u>Style</u>	<u>Description</u>
P22A	"2A"	3 <sup>3</sup> / <sub>4</sub> " w x 4 <sup>3</sup> / <sub>4</sub> " h (white vinyl - coated)
P23A	"3A"	3 <sup>3</sup> / <sub>4</sub> " w x 9 <sup>1</sup> / <sub>4</sub> " h (white vinyl - coated)
P22PL	"2PL"	2 <sup>3</sup> / <sub>4</sub> " w x 3 <sup>3</sup> / <sub>4</sub> " h (white vinyl - coated w/ clear acrylic base)
P24PL	"4PL"	3 <sup>7</sup> / <sub>8</sub> " w x 5 <sup>3</sup> / <sub>8</sub> " h (larger version of 2PL)
P2MI	"Mini"	2 <sup>1</sup> / <sub>4</sub> " w x 3 <sup>1</sup> / <sub>4</sub> " h (your choice of clear or black acrylic)

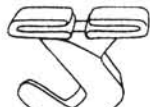

P2CCP



P2SUC

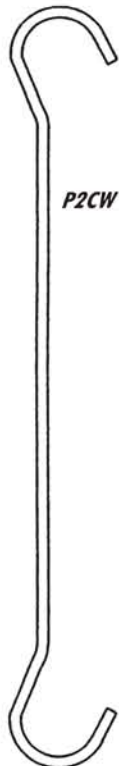

P2CCW



P2CCW



P2SH2



P2SWC



P2CCG



P2HC



P2ICC



P2SH

**CEILING HOOKS**

Both styles attach to standard drop-ceiling "T-Bar" rails.

P2CCW Wire Loop - Style

P2CCP White Plastic Hook

**WIRE CEILING HANGERS (ZINC)**

P2CW4 4" length

P2CW6 6" length

P2CW12 12" length

P2CW16 16" length

**SUCTION HOOKS**

1<sup>5</sup>/<sub>8</sub>" diameter suction cup with metal hook.

P2SUC

**S - HOOKS (ZINC)**

P2SH 7/8" long

P2SH2 2" long

**SWIVEL CLIP (white or black)**

P2SWC 1<sup>7</sup>/<sub>8</sub>" long

P2SWCX 4<sup>1</sup>/<sub>8</sub>" long

**"HERCULES" CLIP (white or black)**

P2HC

**PLASTIC CHAIN AND CLIPS**

All components available in white or black

P2C10 10' chain section

P2GCLP Grip - clips (pkg. of 10)

P2CCL Connector links (pkg. of 3)

P2CSH S - Hooks (pkg. of 3)

P2CCG 8' chain with 30 grip clips

**INVENTORY CONTROL CLIPS**

Clips behind product on all types of display hooks (.149 to .250 in diameter). Helps keep merchandise forward, giving merchandise a fully stocked appearance.

P2ICC

**SOCK HANGERS (black)**

P2SH

These powerful clips are also available for use on your **Slatwall and Gridwall** displays - See Sections B & C.

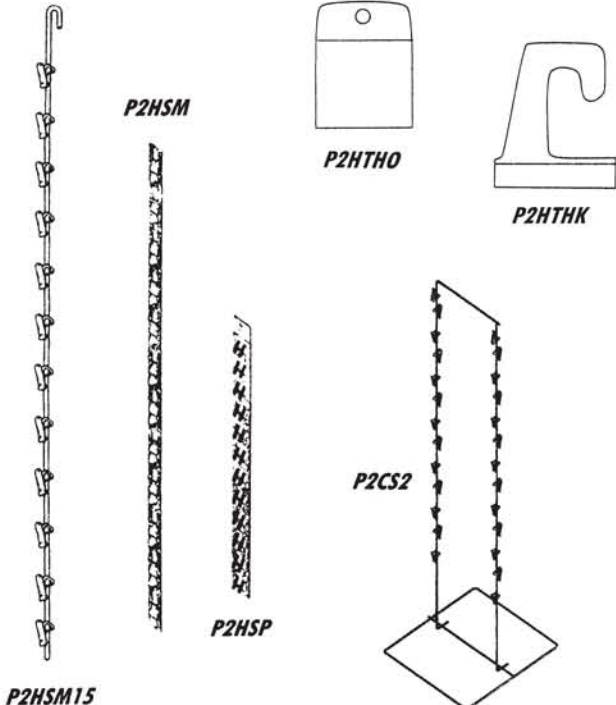

**HANG TABS**

Attach them to merchandise for easy hook displaying. Super strong adhesive pads won't pull off.

- P2HTHO** 1 1/4" h x 7/8" w Sheet of 36 - Closed Hole
- P2HTHK** 1 1/2" h x 1 1/2" w Sheet of 20 - Open Hook

**HANG STRIP RETAILERS**

- P2HSP** 22" length with adhesive top pad and 12 tab hooks.
- P2HSM** 28 1/2" length metal with 12 hooks.
- P2HSM15** 39" length metal with 15 adjustable clips.

**COUNTER TOP STRIP RETAILERS**

- P2CS2** Two, 13-clip wands (26 total) with 9" x 10" base
- P2CS3** Three, 13-clip wands (39 total) with 9" x 15" base

**GIFT CERTIFICATES**

Great gifts for your customers to purchase for their friends. Choose one of our standard designs or personalize them with your store name and address.

- P2GC100** 100 Standard Certificates w/ envelopes
- P2GC100X** 100 Deluxe Gold Foil Certificates w/ envelopes

Ask for more information about personalized certificates!

**SHOPPING BASKETS**

12 - BASKET SET includes two each of 6 different colors. Stand included.

- P2SBSET** INDIVIDUAL BASKETS available in blue.
- P2SB6**

**SHOPPING CARTS**

"VersaCart" system combines small (40 1/2" h x 19" w x 22" l), nestable steel carts with standard shopping baskets. Your customer may choose to carry a basket, or to outfit the cart with one or two baskets. A sturdy, convertible system that takes up only a small amount of your precious retail space!

- P9VC** **VERSACART**
- P9VB** **BASKETS** (red, blue, black, green)

Custom basket imprinting is available on your baskets!



**P2GC**

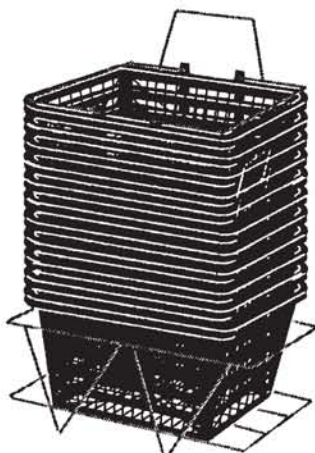

**P2SBSET**

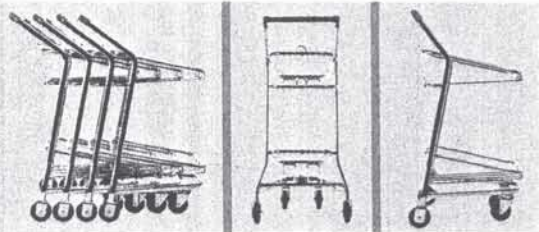
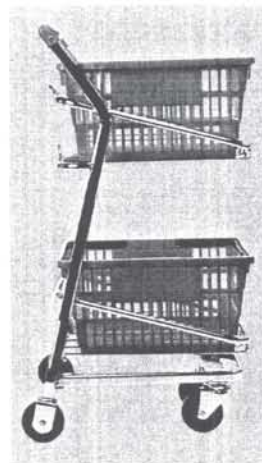

**P9VC**

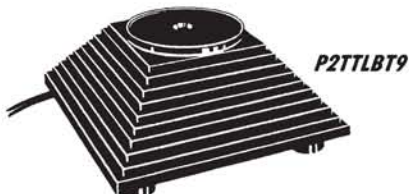

**P2TTLBT9**

Colored halogen lighting changes from white to pink, aqua, orange, blue, green, and purple. Top covers are also available for this unit.

**MOTORIZED TURNTABLES**

Attention-getting displays start with one of our turntable units. We offer several sizes and specifications to meet your needs.

	<u>PLATTER SIZE</u>	<u>CAPACITY</u>	<u>SPEED</u>	<u>OTHER</u>
<b>P2TTLBT9</b>	4 1/8" diameter	2 lbs.	1 RPM	AC unit with multi-colored bottom-lighting
<b>P2TTTN1</b>	3 1/2" diameter	8 lbs.	4 RPM	AC unit
<b>P9TT1046B</b>	6" diameter	15 lbs.	3 RPM	Runs on 4 "D" cells in external battery pack
<b>P2TT7MS</b>	7" diameter	12 lbs.	1 RPM	Runs on 1 "D" cell and has mirrored top and sides. Choose SILVER or GOLD finish.
<b>P2TTTNX6</b>	5 1/2" diameter	25 lbs.	1 RPM	AC unit
<b>P2TT1058</b>	8" diameter	25 lbs.	3 RPM	AC unit
<b>P2TT10512E</b>	12" diameter	25 lbs.	3 RPM	AC unit with electrical outlet on platter

**TURNTABLE TOPS**

<b>P20602</b>	6" diameter mirrored top with 2" high mirrored edges	
<b>P21202</b>	12" diameter mirrored top with 2" high mirrored edges	
<b>A2MR4</b>	4" diameter beveled mirror top	
<b>A9MR6</b>	6" diameter beveled mirror top	BY SPECIAL ORDER

**NON-MOTORIZED TURNTABLES**

Acrylic lazy-susan bases are 3/4" high. Stocked in white, but available in black by special order.

<b>P2RTW8</b>	8" diameter
<b>P2RTW12</b>	12" diameter

**CEILING ROTATORS**

Add some motion to your ceiling displays!

	<u>CAPACITY</u>	<u>SPEED</u>	<u>OTHER</u>
<b>A2BOCD</b>	2 lbs.	3 RPM	Runs on 1 "D" cell
<b>P2CT105</b>	15 lbs.	3 RPM	AC unit



**P2TTTN1**



**P9TT1046B**

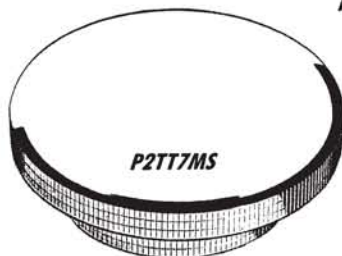

**P2TT7MS**



**P2TTTNX6**



**P2TT1058**



**A2MR4**



**P2CT105**



**A2BOCD**



**P2TT10512E**

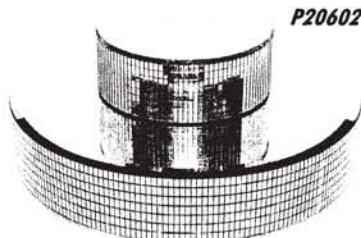

**P20602**



**P2RTW12**

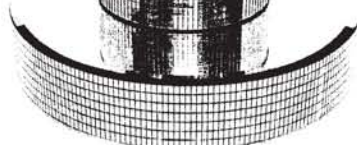

**P21202**

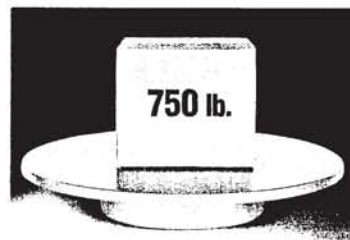

Need a turntable with some serious weight capacity? Give us a call!